

All dimensions are in inches - for reference only, subject to change.

**CYLINDER VALVE OUTLET PLUGS**

PART NUMBER	DESCRIPTION	L
PLU-590BR	BRASS W/ BUNA O-RING LESS RING & CHAIN	1.00"
PLU-590BR-R	BRASS W/ BUNA O-RING	1.00"
PLU-590CH-R	NICKEL PLATED BRASS W/ BUNA O-RING	1.00"
PLU-590SS-TR	303 STAINLESS STEEL W/ PTFE O-RING	1.00"

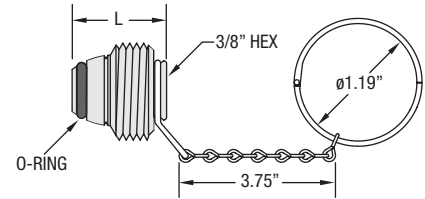

**INLETS X 1/4" MALE NATIONAL PIPE THREAD (INCLUDES NUT & NIPPLE)**

PART NUMBER	DESCRIPTION	L
INL-590BR-4M-56R	BRASS W/ FILTER	3.50"
INL-CV590BR-4M	BRASS W/ CHECK VALVE	3.50"
INL-590CH-4M-56R	NICKEL PLATED BRASS W/ FILTER	3.50"
INL-CV590CH-4M	NICKEL PLATED BRASS W/ CHECK VALVE	3.50"
INL-590SS-4M-42	STAINLESS STEEL	2.625"
INL-590SS-4M-42V	STAINLESS STEEL W/ VITON O-RING	2.625"
INL-590SS-4M-56	STAINLESS STEEL	3.50"
INL-590SS-4M-56V	STAINLESS STEEL W/ VITON O-RING	3.00"
INL-590SS-4M-70R	STAINLESS STEEL W/ FILTER	4.375"
INL-CV590SS-4M	STAINLESS STEEL W/ CHECK VALVE	2.625"

BRASS OR NICKEL PLATED BRASS NUT & NIPPLE

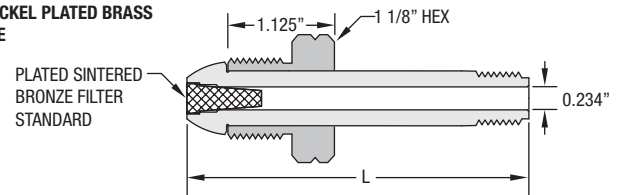

STAINLESS STEEL 303 NUT & 316L NIPPLE

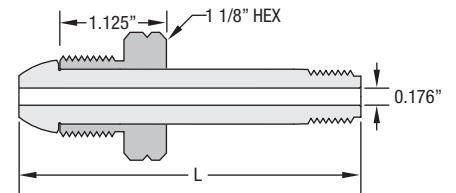

**INLETS X 1/4 MALE FACE SEAL (INCLUDES 303 SS NUT & 316L SS NIPPLE)**

PART NUMBER	DESCRIPTION	L
INL-590SS-4MFS-44	STAINLESS STEEL 12 Ra	2.75"
INL-590SS-4MFS-44V	STAINLESS STEEL W/ VITON O-RING 12 Ra	2.75"
INL-590SS-4MFS-P	STAINLESS STEEL 9 Ra EP	2.75"

Available with Check Valve upon request      EP = Electropolished ID

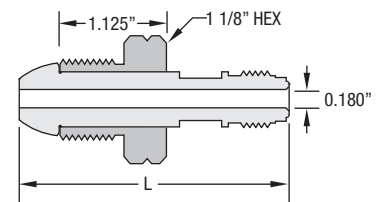

**INLETS X ORBITAL TUBE WELD STUB (INCLUDES SILVER PLATED 303 SS NUT & 316L SS NIPPLE)**

PART NUMBER	DESCRIPTION	L	T
INL-590SS-4TS-42F	STAINLESS STEEL 12 Ra *	2.625"	1/4" OD x .035" WALL
INL-590SS-4TS-P	STAINLESS STEEL 9 Ra EP *	2.625"	1/4" OD x .035" WALL
INL-CV590SS-4TS	STAINLESS STEEL W/ CHECK VALVE	2.625"	1/4" OD x .035" WALL
INL-590SS-6TS	STAINLESS STEEL 12 Ra	2.625"	3/8" OD x .035" WALL
INL-590SS-6TS-P	STAINLESS STEEL 9 Ra EP	2.625"	3/8" OD x .035" WALL
INL-590SS-8TS	STAINLESS STEEL 12 Ra	2.625"	1/2" OD x .049" WALL
INL-590SS-8TS-P	STAINLESS STEEL 9 Ra EP	2.625"	1/2" OD x .049" WALL

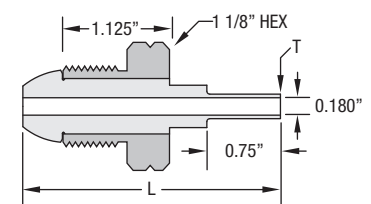

\*PTH-7 Pigtail Handle available

EP = Electropolished ID

**COMPLETE PIGTAIL CONNECTION X ORBITAL TUBE WELD STUB (INCLUDES SILVER PLATED 303 SS NUT, 316L SS NIPPLE & 303 SS BLANK CAP)**

PART NUMBER	DESCRIPTION	L	T
PT-590SS-4TS-P	STAINLESS STEEL 9 Ra EP **	2.625"	1/4"OD x .035" WALL
PT-590SS-4TS-VF-P	SS W/ VITON O-RING 9 Ra EP *	2.625"	1/4"OD x .035" WALL
PT-590SS-6TS-P	STAINLESS STEEL 9 Ra EP	2.625"	3/8"OD x .035" WALL
PT-590SS-8TS-P	STAINLESS STEEL 9 Ra EP	2.625"	1/2"OD x .049" WALL

<sup>†</sup>Blank cap available with ring & chain on request    <sup>\*</sup>PTH-7 Pigtail Handle available    EP = Electropolished ID

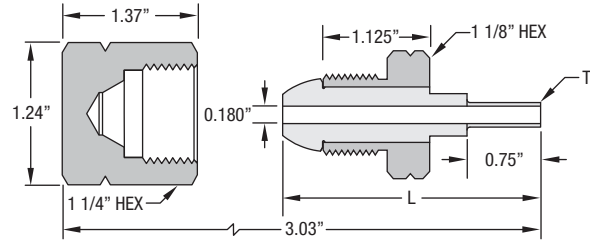

**COMPLETE PIGTAIL CONNECTION X 1/4 MALE FACE SEAL (INCLUDES 303 SS NUT, 316L SS NIPPLE & 303 SS BLANK CAP)**

PART NUMBER	DESCRIPTION	L	T
PT-590SS-4MFS-P	STAINLESS STEEL 9 Ra EP †	2.625"	1/4"OD x .035 WALL

<sup>†</sup>Blank cap available with ring & chain on request    EP = Electropolished ID

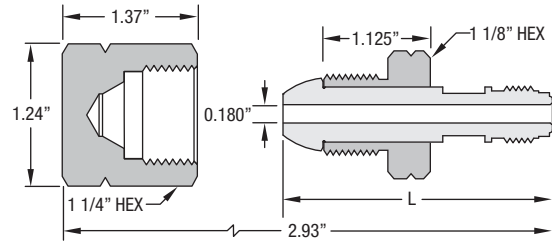

**INLET OPTIONS & ACCESSORIES**

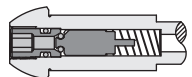

**CV**  
W/ INTEGRAL CHECK VALVE

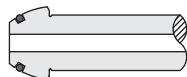

**V**  
W/ VITON O-RING

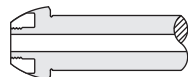

**Q**  
W/ SOFT PCTFE TIP



**FR**  
W/ FLOW RESTRICTOR ORIFICE

**PTH-7**  
<sup>\*</sup>PIGTAIL HANDLE  
SIZE 7  
FOR USE ON  
1/4" TUBE STUB  
INLETS ONLY



6 1/8"

**VALVE OUTLET ADAPTORS**

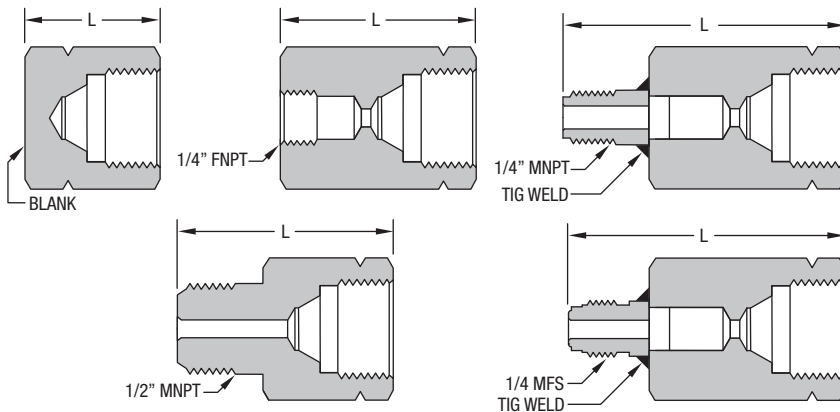

PART NUMBER	DESCRIPTION	L
AD-590FBR-4FNPT	BRASS 1/4" FNPT	2.00"
AD-590FBR-4MNPT	BRASS 1/4" MNPT	2.88"
AD-590FBR-8MNPT	BRASS 1/2" MNPT	2.12"
AD-590FSS-BL	303 SS BLANK CAP <sup>†</sup>	1.37"
AD-590FSS-4FNPT	316L SS 1/4" FNPT	2.00"
AD-590FSS-4MNPT	316L SS 1/4" MNPT	2.88"
AD-590FSS-8MNPT	316L SS 1/2" MNPT	2.12"
AD-590FSS-4MFS	316L SS 1/4 MALE FACE SEAL	2.83"

<sup>†</sup>Blank cap available with ring & chain on request

**3 PIECE ADAPTORS (INCLUDES 303 SS NUT, 316L SS NIPPLE & SS OUTLET ADAPTOR)**

PART NUMBER	DESCRIPTION	L
AD-590M716M-SS	STAINLESS STEEL CGA 590 MALE X CGA 716 MALE	4.00"
AD-590MBS6M-SS	STAINLESS STEEL CGA 590 MALE X BS 6 MALE	3.50"
AD-590MD6M-SS	STAINLESS STEEL CGA 590 MALE X DIN 6 MALE	3.25"
AD-590MAFNORCM-SS	STAINLESS STEEL CGA 590 MALE X AFNOR C MALE	3.50"
AD-590MJ26RM-SS	STAINLESS STEEL CGA 590 MALE X JIS 26R MALE	3.25"

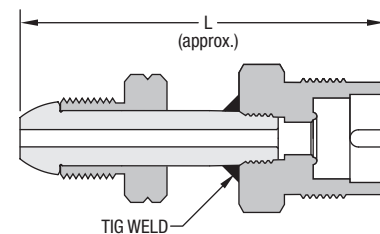

VALVE, FITTING OR OTHER COMPONENT FUNCTION, PROPER INSTALLATION, MATERIALS COMPATIBILITY, ADEQUATE RATINGS, OPERATION AND MAINTENANCE ARE THE RESPONSIBILITY OF THE SYSTEM DESIGNER AND USER.



PRODUCT FAILURE, IMPROPER SELECTION OR IMPROPER USE OF THE PRODUCTS AND/OR SYSTEMS DESCRIBED HEREIN OR RELATED ITEMS CAN CAUSE DEATH, PERSONAL INJURY AND PROPERTY DAMAGE.



**GasFlo Products Inc. CGA Compressed Gas Service Cylinder Connections are Manufactured to CGA V-1 Standards**  
Additional materials and configurations available on request. Minimum order quantities may be required.

**19 Industrial Road, Fairfield, NJ 07004 Phone: 973-276-9011 Fax: 973-276-9014 www.gasflo.com**

